

CA45 Series

Standard Chip Tantalum Capacitors

Features

- Epoxy molded encapsulation, Chip, Easy for integration, Polarized;
- Small in size, Light in weight, Stable in electrical & storage performances, Long life-span, High reliability;
- Typical applications include decoupling and filtering in industrial and automotive end applications such as DC/DC converters, portable electronics, telecommunications, and control units;
- Operative Standard: QJ/PWV109-2003;

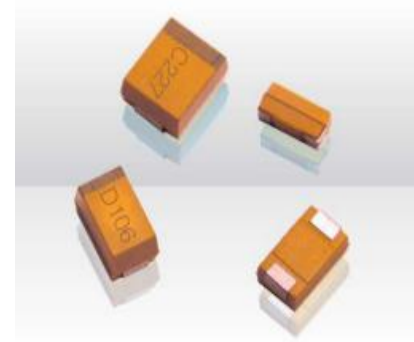

Dimensions (mm)

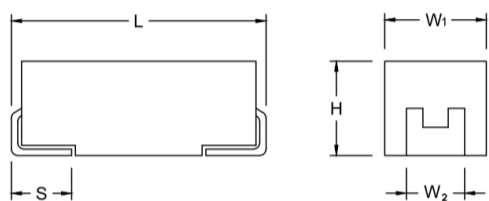

Case Code	EIA Code	EIA Metric	L	W ₁	H	W ₂	S
A	1206	3216-16	3.20±0.20	1.60±0.20	1.60±0.20	0.80±0.20	1.20±0.20
B	1210	3528-19	3.50±0.20	2.80±0.20	1.90±0.20	0.80±0.20	2.20±0.20
C	2312	6032-25	6.00±0.20	3.20±0.20	2.50±0.20	1.30±0.20	2.20±0.20
D	2917	7343-28	7.30±0.20	4.30±0.20	2.80±0.20	1.30±0.20	2.40±0.20
E	2917	7343-43	7.30±0.40	4.30±0.40	4.10±0.40	1.30±0.20	2.40±0.20
V	2924	7361-36	7.30±0.40	6.10±0.40	3.60±0.40	1.35±0.20	3.00±0.20
W	2924	7361-41	7.30±0.40	6.10±0.40	4.10±0.40	1.35±0.20	3.00±0.20
G	3329	8575-45	8.50±0.40	7.50±0.40	4.50±0.40	1.80±0.20	4.50±0.20
S	4335	11090-45	11.0±0.40	9.00±0.40	4.50±0.40	1.50±0.20	7.00±0.20
T	4349	110125-55	11.0±0.40	12.5±0.40	5.50±0.40	1.50±0.20	10.5±0.20

How to order

CA45	-	D	010	M	107	T
Type	Separator	Case Size	Rated DC voltage	Tolerance	Capacitance Code	Package
		See table above	2R5=2.5Vdc; 004=4Vdc; 6R3=6.3Vdc; 010=10Vdc 016=16Vdc; 020=20Vdc 025=25Vdc; 035=35Vdc 050=50Vdc; 063=63Vdc 075=75Vdc; 100=100Vdc	K=±10% M=±20%	pF code: 1st two digits present significant figures, 3rd digit represents multiplier (number of zeros to follow)	T=Reel W=Waffle B=Bulk

Environmental Compliance

RoHS Compliant (6/6) according to Directive 2002/95/EC when ordered with 100%Sn solder, Gold plated or Non-magnetic 100% Sn solder.



Marking

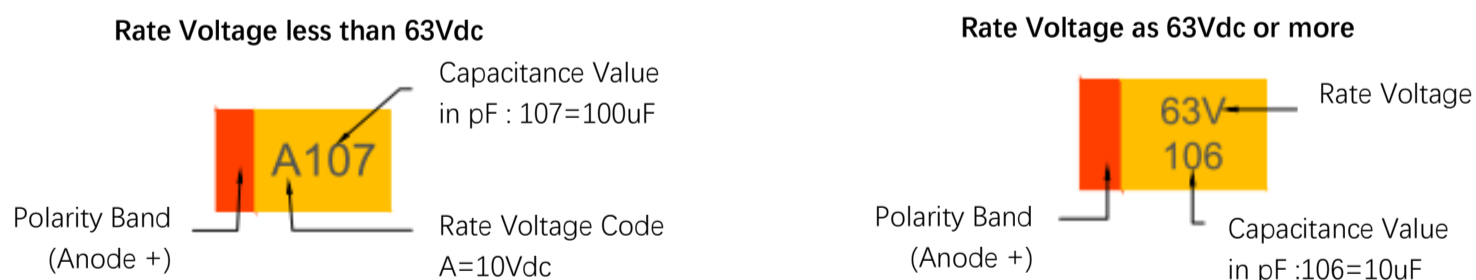

Technical Specifications

Technical Data		All technical data relate to an ambient temperature of +25°C											
Capacitance Range		0.10 μF ~1000 μF											
Capacitance Tolerance		±10%; ±20%;											
Rated Voltage (V _R)	≤+85°C:	2.5	4	6.3	10	16	20	25	35	50	63	75	100
Category Voltage (V _C)	≤+125°C:	1.7	2.7	4	6.3	10	15	17	23	33	40	50	63
Surge Voltage (V _S)	≤+85°C:	3.3	5.2	8	13	20	26	32	46	65	82	97	130
Surge Voltage (V _S)	≤+125°C:	2.2	3.4	5	8	13	16	20	28	40	50	60	80
Temperature Range		-55°C to +125°C											
Termination Finished		Sn Plating (standard), Gold and SnPb Plating upon request											

**CAPACITANCE AND RATED VOLTAGE RANGE
(LETTER DENOTES CASE SIZE)**

Rated Voltage (V)	2.5	4	6.3	10	16	20	25	35	50	63
Capacitance (μF)	Case Code									
0.47								A	A	
0.68								A	A	
1								A/B	A/B	C
1.5								A/B	B/C	D
2.2							A	A/B	B/C/D	D
3.3						A	A/B/C	B/C	C/D	D
4.7						A	A/B/C	B/C/D	C/D	E
6.8					A	A/B/C	B/C/D	B/C/D	C/D/E	E
10				A	A/B	A/B/C	B/C/D	C/D/E	D/E/V	E/W
15				A	A/B/C	B/C/D	C/D	C/D/E	D/E/V	E/V/W
22			A	A/B	A/B/C	B/C/D	C/D	C/D/E	E/V	V/W/G
33			A	A/B/C	B/C/D	C/D	D/E	D/E	W/G	T
47		A	A/B	A/B/C	C/D	C/D/E	D/E	D/E/V	S/T	T
68		A	A/B/C	B/C/D	C/D	C/D/E	D/E	E/V	T	T
100		A/B	A/B/C	B/C/D	C/D/E	D/E/V	E/V/W	G/S/T	T	
150		B/C/D	B/C/D	C/D/E	D/E/V	D/E/V	E/V	T		
220		B/C/D	B/C/D/E	C/D/E	D/E/V	E/V/W	G/S			
330		C/D	C/D/E	D/E/V	E/V/W	E/V	T			
470		C/D/E	D/E/V	E/V	E/W	T				
680	C/D/E	D/E	E/V/W	E/S/T	T					
1000	D/E	D/E/V	E/V/G	T						
1500	D/E/V	E/V	T							
2200	V									

RATING & PART NUMBER REFERENCE

Part Number	Rated Voltage (V)	Capacitance (μF)	Case Code	Rated Temp (°C)	Category Voltage	Category Temp (°C)	Max DCL(μA) @25°C	Max DF(%) @25°C 100Hz	Max ESR(mΩ) @25°C 100KHz	Max. Ripple @100KHz IRMS (A)		
										25°C	85°C	125°C
CA45-C2R5#687T	2.5	680	C	85	1.7	125	17.0	18	0.2	0.671	0.402	0.268
CA45-D2R5#687T	2.5	680	D	85	1.7	125	17.0	16	0.2	0.725	0.435	0.290
CA45-E2R5#687T	2.5	680	E	85	1.7	125	17.0	10	0.2	0.791	0.474	0.316
CA45-D2R5#108T	2.5	1000	D	85	1.7	125	25.0	20	0.2	0.725	0.435	0.290
CA45-E2R5#108T	2.5	1000	E	85	1.7	125	25.0	14	0.2	0.791	0.474	0.316
CA45-D2R5#158T	2.5	1500	D	85	1.7	125	37.5	60	0.2	0.725	0.435	0.290
CA45-E2R5#158T	2.5	1500	E	85	1.7	125	37.5	20	0.2	0.791	0.474	0.316
CA45-V2R5#158T	2.5	1500	V	85	1.7	125	37.5	20	0.2	0.866	0.520	0.346
CA45-V2R5#228T	2.5	2200	V	85	1.7	125	55.0	50	0.2	0.866	0.520	0.346
CA45-A004#476T	4	47	A	85	2.7	125	1.9	11	8	0.090	0.054	0.036
CA45-A004#686T	4	68	A	85	2.7	125	2.7	24	2.5	0.161	0.097	0.064
CA45-A004#107T	4	100	A	85	2.7	125	4.0	30	2	0.180	0.108	0.072
CA45-B004#107T	4	100	B	85	2.7	125	4.0	12	0.9	0.289	0.173	0.115
CA45-B004#157T	4	150	B	85	2.7	125	6.0	10	1.5	0.224	0.134	0.089
CA45-C004#157T	4	150	C	85	2.7	125	6.0	6	0.3	0.548	0.329	0.219
CA45-D004#157T	4	150	D	85	2.7	125	6.0	8	0.8	0.362	0.217	0.145
CA45-B004#227T	4	220	B	85	2.7	125	8.8	18	1	0.274	0.164	0.110
CA45-C004#227T	4	220	C	85	2.7	125	8.8	12	1.1	0.286	0.172	0.114
CA45-D004#227T	4	220	D	85	2.7	125	8.8	8	0.8	0.362	0.217	0.145
CA45-C004#337T	4	330	C	85	2.7	125	13.2	10	0.9	0.316	0.190	0.126
CA45-D004#337T	4	330	D	85	2.7	125	13.2	8	0.7	0.387	0.232	0.155
CA45-C004#477T	4	470	C	85	2.7	125	18.8	14	0.5	0.424	0.255	0.170
CA45-D004#477T	4	470	D	85	2.7	125	18.8	8	0.5	0.458	0.275	0.183
CA45-E004#477T	4	470	E	85	2.7	125	18.8	10	0.5	0.500	0.300	0.200
CA45-D004#687T	4	680	D	85	2.7	125	27.2	12	0.5	0.458	0.275	0.183
CA45-E004#687T	4	680	E	85	2.7	125	27.2	14	0.9	0.373	0.224	0.149
CA45-D004#108T	4	1000	D	85	2.7	125	40.0	60	0.3	0.592	0.355	0.237
CA45-E004#108T	4	1000	E	85	2.7	125	40.0	14	0.3	0.645	0.387	0.258
CA45-V004#108T	4	1000	V	85	2.7	125	40.0	12	0.2	0.866	0.520	0.346
CA45-E004#158T	4	1500	E	85	2.7	125	60.0	30	0.2	0.791	0.474	0.316
CA45-V004#158T	4	1500	V	85	2.7	125	60.0	30	0.2	0.866	0.520	0.346
CA45-A6R3#226T	6.3	22	A	85	4	125	1.4	6	3	0.147	0.088	0.059
CA45-A6R3#336T	6.3	33	A	85	4	125	2.1	8	2.2	0.172	0.103	0.069
CA45-A6R3#476T	6.3	47	A	85	4	125	3.0	12	2.5	0.161	0.097	0.064
CA45-B6R3#476T	6.3	47	B	85	4	125	3.0	6	1	0.274	0.164	0.110
CA45-A6R3#686T	6.3	68	A	85	4	125	4.3	20	4	0.127	0.076	0.051
CA45-B6R3#686T	6.3	68	B	85	4	125	4.3	8	0.9	0.289	0.173	0.115
CA45-C6R3#686T	6.3	68	C	85	4	125	4.3	6	1.2	0.274	0.164	0.110
CA45-A6R3#107T	6.3	100	A	85	4	125	6.3	35	2	0.180	0.108	0.072
CA45-B6R3#107T	6.3	100	B	85	4	125	6.3	12	1.7	0.210	0.126	0.084
CA45-C6R3#107T	6.3	100	C	85	4	125	6.3	8	0.9	0.316	0.190	0.126
CA45-B6R3#157T	6.3	150	B	85	4	125	9.5	10	1.2	0.250	0.150	0.100
CA45-C6R3#157T	6.3	150	C	85	4	125	9.5	8	1.2	0.274	0.164	0.110
CA45-D6R3#157T	6.3	150	D	85	4	125	9.5	8	0.7	0.387	0.232	0.155
CA45-B6R3#227T	6.3	220	B	85	4	125	13.9	30	1.2	0.250	0.150	0.100
CA45-C6R3#227T	6.3	220	C	85	4	125	13.9	10	0.7	0.359	0.215	0.143
CA45-D6R3#227T	6.3	220	D	85	4	125	13.9	8	0.4	0.512	0.307	0.205
CA45-E6R3#227T	6.3	220	E	85	4	125	13.9	8	0.4	0.559	0.335	0.224
CA45-C6R3#337T	6.3	330	C	85	4	125	20.8	12	0.5	0.424	0.255	0.170
CA45-D6R3#337T	6.3	330	D	85	4	125	20.8	8	0.4	0.512	0.307	0.205
CA45-E6R3#337T	6.3	330	E	85	4	125	20.8	8	0.4	0.559	0.335	0.224
CA45-D6R3#477T	6.3	470	D	85	4	125	29.6	12	0.3	0.592	0.355	0.237
CA45-E6R3#477T	6.3	470	E	85	4	125	29.6	10	0.4	0.559	0.335	0.224
CA45-V6R3#477T	6.3	470	V	85	4	125	29.6	10	0.4	0.612	0.367	0.245

- # To complete part number , insert K for ±10% or M for ±20% .Designates capacitance tolerance.
- Please do not use multimeter through the measuring procedures.
- Capacitance and DF measured at :100Hz, U₊=2.2~-1.0V, U₋=1.0~-0.5V, Frequency=100Hz.Test only applied in series equivalent circuit.
- Voltage derating is applied at +125°C. (The DCL parameter should be read after 5 minutes when it connected to the circuit) .
- Special size and demand could consult with us.

RATING & PART NUMBER REFERENCE

Part Number	Rated Voltage (V)	Capacitance (μF)	Case Code	Rated Temp (°C)	Category Voltage	Category Temp (°C)	Max DCL(μA) @25°C	Max DF(%) @25°C 100Hz	Max ESR(mΩ) @25°C 100KHz	Max. Ripple @100KHz IRMS (A)		
										25°C	85°C	125°C
CA45-E6R3#687T	6.3	680	E	85	4	125	42.8	10	0.5	0.500	0.300	0.200
CA45-V6R3#687T	6.3	680	V	85	4	125	42.8	10	0.5	0.548	0.329	0.219
CA45-W6R3#687T	6.3	680	W	85	4	125	42.8	12	0.2	1.000	0.600	0.400
CA45-E6R3#108T	6.3	1000	E	85	4	125	63.0	20	0.2	0.791	0.474	0.316
CA45-V6R3#108T	6.3	1000	V	85	4	125	63.0	15	0.2	0.866	0.520	0.346
CA45-G6R3#108W	6.3	1000	G	85	4	125	63.0	16	0.2	1.095	0.657	0.438
CA45-T6R3#158W	6.3	1500	T	85	4	125	94.5	16	0.2	1.285	0.771	0.514
CA45-A010#106T	10	10	A	85	6.3	125	1.0	6	3	0.147	0.088	0.059
CA45-A010#156T	10	15	A	85	6.3	125	1.5	6	3.2	0.143	0.086	0.057
CA45-A010#226T	10	22	A	85	6.3	125	2.2	10	3	0.147	0.088	0.059
CA45-B010#226T	10	22	B	85	6.3	125	2.2	6	1.9	0.199	0.119	0.079
CA45-A010#336T	10	33	A	85	6.3	125	3.3	15	1.7	0.196	0.117	0.078
CA45-B010#336T	10	33	B	85	6.3	125	3.3	6	1.8	0.204	0.122	0.082
CA45-C010#336T	10	33	C	85	6.3	125	3.3	6	1.5	0.245	0.147	0.098
CA45-A010#476T	10	47	A	85	6.3	125	4.7	40	2	0.180	0.108	0.072
CA45-B010#476T	10	47	B	85	6.3	125	4.7	8	1	0.274	0.164	0.110
CA45-C010#476T	10	47	C	85	6.3	125	4.7	6	0.9	0.316	0.190	0.126
CA45-B010#686T	10	68	B	85	6.3	125	6.8	6	1.4	0.231	0.139	0.093
CA45-C010#686T	10	68	C	85	6.3	125	6.8	6	0.8	0.335	0.201	0.134
CA45-D010#686T	10	68	D	85	6.3	125	6.8	6	0.8	0.362	0.217	0.145
CA45-B010#107T	10	100	B	85	6.3	125	10.0	18	1.4	0.231	0.139	0.093
CA45-C010#107T	10	100	C	85	6.3	125	10.0	8	1	0.300	0.180	0.120
CA45-D010#107T	10	100	D	85	6.3	125	10.0	8	0.7	0.387	0.232	0.155
CA45-C010#157T	10	150	C	85	6.3	125	15.0	8	0.9	0.316	0.190	0.126
CA45-D010#157T	10	150	D	85	6.3	125	15.0	8	0.6	0.418	0.251	0.167
CA45-E010#157T	10	150	E	85	6.3	125	15.0	8	0.9	0.373	0.224	0.149
CA45-C010#227T	10	220	C	85	6.3	125	22.0	16	0.9	0.316	0.190	0.126
CA45-D010#227T	10	220	D	85	6.3	125	22.0	8	0.5	0.458	0.275	0.183
CA45-E010#227T	10	220	E	85	6.3	125	22.0	8	0.5	0.500	0.300	0.200
CA45-D010#337T	10	330	D	85	6.3	125	33.0	10	0.5	0.458	0.275	0.183
CA45-E010#337T	10	330	E	85	6.3	125	33.0	8	0.9	0.373	0.224	0.149
CA45-V010#337T	10	330	V	85	6.3	125	33.0	10	0.5	0.548	0.329	0.219
CA45-E010#477T	10	470	E	85	6.3	125	47.0	10	0.5	0.500	0.300	0.200
CA45-V010#477T	10	470	V	85	6.3	125	47.0	10	0.2	0.866	0.520	0.346
CA45-E010#687T	10	680	E	85	6.3	125	68.0	14	0.5	0.500	0.300	0.200
CA45-S010#687W	10	680	S	85	6.3	125	68.0	12	0.2	1.183	0.710	0.473
CA45-T010#687W	10	680	T	85	6.3	125	68.0	12	0.2	1.285	0.771	0.514
CA45-T010#108W	10	1000	T	85	6.3	125	100.0	16	0.2	1.285	0.771	0.514
CA45-A016#685T	16	6.8	A	85	10	125	1.1	6	3.5	0.136	0.082	0.055
CA45-A016#106T	16	10	A	85	10	125	1.6	6	3	0.147	0.088	0.059
CA45-B016#106T	16	10	B	85	10	125	1.6	6	2.5	0.173	0.104	0.069
CA45-A016#156T	16	15	A	85	10	125	2.4	6	2	0.180	0.108	0.072
CA45-B016#156T	16	15	B	85	10	125	2.4	6	2	0.194	0.116	0.077
CA45-C016#156T	16	15	C	85	10	125	2.4	6	1.8	0.224	0.134	0.089
CA45-A016#226T	16	22	A	85	10	125	3.5	15	3	0.147	0.088	0.059
CA45-B016#226T	16	22	B	85	10	125	3.5	6	2.2	0.185	0.111	0.074
CA45-C016#226T	16	22	C	85	10	125	3.5	6	1.5	0.245	0.147	0.098
CA45-B016#336T	16	33	B	85	10	125	5.3	8	2	0.194	0.116	0.077
CA45-C016#336T	16	33	C	85	10	125	5.3	6	1.2	0.274	0.164	0.110
CA45-D016#336T	16	33	D	85	10	125	5.3	6	0.8	0.362	0.217	0.145
CA45-C016#476T	16	47	C	85	10	125	7.5	6	1	0.300	0.180	0.120
CA45-D016#476T	16	47	D	85	10	125	7.5	6	0.9	0.342	0.205	0.137
CA45-C016#686T	16	68	C	85	10	125	10.9	6	1.2	0.274	0.164	0.110
CA45-D016#686T	16	68	D	85	10	125	10.9	6	0.6	0.418	0.251	0.167

- # To complete part number , insert K for ±10% or M for ±20% .Designates capacitance tolerance.
- Please do not use multimeter through the measuring procedures.
- Capacitance and DF measured at :100Hz, U₊=2.2°-1.0V, U₋=1.0°-0.5V, Frequency=100Hz.Test only applied in series equivalent circuit.
- Voltage derating is applied at +125°C. (The DCL parameter should be read after 5 minutes when it connected to the circuit) .
- Special size and demand could consult with us.

RATING & PART NUMBER REFERENCE

Part Number	Rated Voltage (V)	Capacitance (μF)	Case Code	Rated Temp (°C)	Category Voltage	Category Temp (°C)	Max DCL(μA) @25°C	Max DF(%) @25°C 100Hz	Max ESR(mΩ) @25°C 100KHz	Max. Ripple @100KHz IRMS (A)		
										25°C	85°C	125°C
CA45-C016#107T	16	100	C	85	10	125	16.0	8	1	0.300	0.180	0.120
CA45-D016#107T	16	100	D	85	10	125	16.0	6	0.6	0.418	0.251	0.167
CA45-E016#107T	16	100	E	85	10	125	16.0	6	0.9	0.373	0.224	0.149
CA45-D016#157T	16	150	D	85	10	125	24.0	6	0.7	0.387	0.232	0.155
CA45-E016#157T	16	150	E	85	10	125	24.0	8	0.5	0.500	0.300	0.200
CA45-V016#157T	16	150	V	85	10	125	24.0	8	0.5	0.548	0.329	0.219
CA45-D016#227T	16	220	D	85	10	125	35.2	15	0.9	0.342	0.205	0.137
CA45-E016#227T	16	220	E	85	10	125	35.2	10	0.5	0.500	0.300	0.200
CA45-V016#227T	16	220	V	85	10	125	35.2	8	0.5	0.548	0.329	0.219
CA45-E016#337T	16	330	E	85	10	125	52.8	12	0.8	0.395	0.237	0.158
CA45-V016#337T	16	330	V	85	10	125	52.8	12	0.8	0.433	0.260	0.173
CA45-W016#337T	16	330	W	85	10	125	52.8	10	0.2	1.000	0.600	0.400
CA45-E016#477T	16	470	E	85	10	125	75.2	16	0.8	0.395	0.237	0.158
CA45-W016#477T	16	470	W	85	10	125	75.2	12	0.2	1.000	0.600	0.400
CA45-T016#687W	16	680	T	85	10	125	108.8	12	0.1	1.817	1.090	0.727
CA45-A020#335T	20	3.3	A	85	15	125	0.7	4	4.5	0.120	0.072	0.048
CA45-A020#475T	20	4.7	A	85	15	125	0.9	6	3	0.147	0.088	0.059
CA45-A020#685T	20	6.8	A	85	15	125	1.4	6	2.4	0.165	0.099	0.066
CA45-B020#685T	20	6.8	B	85	15	125	1.4	6	2.4	0.177	0.106	0.071
CA45-C020#685T	20	6.8	C	85	15	125	1.4	6	1.9	0.218	0.131	0.087
CA45-A020#106T	20	10	A	85	15	125	2.0	8	5	0.114	0.068	0.046
CA45-B020#106T	20	10	B	85	15	125	2.0	6	2	0.194	0.116	0.077
CA45-C020#106T	20	10	C	85	15	125	2.0	6	1.2	0.274	0.164	0.110
CA45-B020#156T	20	15	B	85	15	125	3.0	6	2	0.194	0.116	0.077
CA45-C020#156T	20	15	C	85	15	125	3.0	6	1.7	0.230	0.138	0.092
CA45-D020#156T	20	15	D	85	15	125	3.0	6	1	0.324	0.194	0.130
CA45-B020#226T	20	22	B	85	15	125	4.4	6	1.8	0.204	0.122	0.082
CA45-C020#226T	20	22	C	85	15	125	4.4	6	1.6	0.237	0.142	0.095
CA45-D020#226T	20	22	D	85	15	125	4.4	6	0.8	0.362	0.217	0.145
CA45-C020#336T	20	33	C	85	15	125	6.6	6	1.2	0.274	0.164	0.110
CA45-D020#336T	20	33	D	85	15	125	6.6	6	0.9	0.342	0.205	0.137
CA45-C020#476T	20	47	C	85	15	125	9.4	6	0.9	0.316	0.190	0.126
CA45-D020#476T	20	47	D	85	15	125	9.4	6	0.7	0.387	0.232	0.155
CA45-E020#476T	20	47	E	85	15	125	9.4	6	0.9	0.373	0.224	0.149
CA45-C020#686T	20	68	C	85	15	125	13.6	8	0.5	0.424	0.255	0.170
CA45-D020#686T	20	68	D	85	15	125	13.6	6	0.4	0.512	0.307	0.205
CA45-E020#686T	20	68	E	85	15	125	13.6	6	0.9	0.373	0.224	0.149
CA45-D020#107T	20	100	D	85	15	125	20.0	8	0.5	0.458	0.275	0.183
CA45-E020#107T	20	100	E	85	15	125	20.0	6	0.4	0.559	0.335	0.224
CA45-V020#107T	20	100	V	85	15	125	20.0	8	0.5	0.548	0.329	0.219
CA45-D020#157T	20	150	D	85	15	125	30.0	10	0.9	0.342	0.205	0.137
CA45-E020#157T	20	150	E	85	15	125	30.0	8	0.3	0.645	0.387	0.258
CA45-V020#157T	20	150	V	85	15	125	30.0	8	0.3	0.707	0.424	0.283
CA45-E020#227T	20	220	E	85	15	125	44.0	12	0.9	0.373	0.224	0.149
CA45-V020#227T	20	220	V	85	15	125	44.0	12	0.9	0.408	0.245	0.163
CA45-W020#227T	20	220	W	85	15	125	44.0	10	0.2	1.000	0.600	0.400
CA45-E020#337T	20	330	E	85	15	125	66.0	12	0.8	0.395	0.237	0.158
CA45-V020#337T	20	330	V	85	15	125	66.0	12	0.8	0.433	0.260	0.173
CA45-T020#477W	20	470	T	85	15	125	94.0	12	0.2	1.285	0.771	0.514
CA45-A025#225T	25	2.2	A	85	17	125	0.6	6	6.3	0.102	0.061	0.041
CA45-A025#335T	25	3.3	A	85	17	125	0.8	6	3.7	0.133	0.080	0.053
CA45-B025#335T	25	3.3	B	85	17	125	0.8	6	3.5	0.146	0.088	0.059
CA45-C025#335T	25	3.3	C	85	17	125	0.8	6	2.5	0.190	0.114	0.076
CA45-A025#475T	25	4.7	A	85	17	125	1.2	6	3.1	0.145	0.087	0.058

- # To complete part number , insert K for ±10% or M for ±20% .Designates capacitance tolerance.
- Please do not use multimeter through the measuring procedures.
- Capacitance and DF measured at :100Hz, U₊=2.2^o-1.0V, U₋=1.0^o-0.5V, Frequency=100Hz.Test only applied in series equivalent circuit.
- Voltage derating is applied at +125°C. (The DCL parameter should be read after 5 minutes when it connected to the circuit) .
- Special size and demand could consult with us.

RATING & PART NUMBER REFERENCE

Part Number	Rated Voltage (V)	Capacitance (μF)	Case Code	Rated Temp (°C)	Category Voltage	Category Temp (°C)	Max DCL(μA) @25°C	Max DF(%) @25°C 100Hz	Max ESR(mΩ) @25°C 100KHz	Max. Ripple @100KHz IRMS (A)		
										25°C	85°C	125°C
CA45-B025#475T	25	4.7	B	85	17	125	1.2	6	1.5	0.224	0.134	0.089
CA45-C025#475T	25	4.7	C	85	17	125	1.2	6	2.4	0.194	0.116	0.077
CA45-B025#685T	25	6.8	B	85	17	125	1.7	6	2.8	0.164	0.098	0.065
CA45-C025#685T	25	6.8	C	85	17	125	1.7	6	1.9	0.218	0.131	0.087
CA45-D025#685T	25	6.8	D	85	17	125	1.7	6	1.4	0.274	0.164	0.110
CA45-B025#106T	25	10	B	85	17	125	2.5	6	2.5	0.173	0.104	0.069
CA45-C025#106T	25	10	C	85	17	125	2.5	6	1.5	0.245	0.147	0.098
CA45-D025#106T	25	10	D	85	17	125	2.5	6	1	0.324	0.194	0.130
CA45-C025#156T	25	15	C	85	17	125	3.8	6	1.5	0.245	0.147	0.098
CA45-D025#156T	25	15	D	85	17	125	3.8	6	1	0.324	0.194	0.130
CA45-C025#226T	25	22	C	85	17	125	5.5	6	1.4	0.254	0.152	0.101
CA45-D025#226T	25	22	D	85	17	125	5.5	6	0.8	0.362	0.217	0.145
CA45-D025#336T	25	33	D	85	17	125	8.3	6	0.7	0.387	0.232	0.155
CA45-E025#336T	25	33	E	85	17	125	8.3	6	0.9	0.373	0.224	0.149
CA45-D025#476T	25	47	D	85	17	125	11.8	6	0.7	0.387	0.232	0.155
CA45-E025#476T	25	47	E	85	17	125	11.8	6	0.9	0.373	0.224	0.149
CA45-D025#686T	25	68	D	85	17	125	17.0	6	0.7	0.387	0.232	0.155
CA45-E025#686T	25	68	E	85	17	125	17.0	6	0.9	0.373	0.224	0.149
CA45-E025#107T	25	100	E	85	17	125	25.0	10	0.3	0.645	0.387	0.258
CA45-V025#107T	25	100	V	85	17	125	25.0	8	0.3	0.707	0.424	0.283
CA45-W025#107T	25	100	W	85	17	125	25.0	8	0.25	0.894	0.537	0.358
CA45-E025#157T	25	150	E	85	17	125	37.5	10	0.8	0.395	0.237	0.158
CA45-V025#157T	25	150	V	85	17	125	37.5	10	0.4	0.612	0.367	0.245
CA45-G025#227W	25	220	G	85	17	125	55.0	10	0.2	1.095	0.657	0.438
CA45-S025#227W	25	220	S	85	17	125	55.0	10	0.2	1.183	0.710	0.473
CA45-T025#337W	25	330	T	85	17	125	82.5	10	0.2	1.285	0.771	0.514
CA45-A035#474T	35	0.47	A	85	23	125	0.5	4	12	0.074	0.044	0.029
CA45-A035#684T	35	0.68	A	85	23	125	0.5	4	8	0.090	0.054	0.036
CA45-A035#105T	35	1	A	85	23	125	0.5	4	7.5	0.093	0.056	0.037
CA45-B035#105T	35	1	B	85	23	125	0.5	4	4	0.137	0.082	0.055
CA45-A035#155T	35	1.5	A	85	23	125	0.5	6	7	0.096	0.058	0.039
CA45-B035#155T	35	1.5	B	85	23	125	0.5	6	5	0.122	0.073	0.049
CA45-A035#225T	35	2.2	A	85	23	125	0.8	6	4.5	0.120	0.072	0.048
CA45-B035#225T	35	2.2	B	85	23	125	0.8	6	4	0.137	0.082	0.055
CA45-B035#335T	35	3.3	B	85	23	125	1.2	6	3.5	0.146	0.088	0.059
CA45-C035#335T	35	3.3	C	85	23	125	1.2	6	2.5	0.190	0.114	0.076
CA45-B035#475T	35	4.7	B	85	23	125	1.6	6	3.1	0.156	0.093	0.062
CA45-C035#475T	35	4.7	C	85	23	125	1.6	6	2.2	0.202	0.121	0.081
CA45-D035#475T	35	4.7	D	85	23	125	1.6	6	1.5	0.265	0.159	0.106
CA45-B035#685T	35	6.8	B	85	23	125	2.4	6	3	0.158	0.095	0.063
CA45-C035#685T	35	6.8	C	85	23	125	2.4	6	1.8	0.224	0.134	0.089
CA45-D035#685T	35	6.8	D	85	23	125	2.4	6	1.3	0.284	0.171	0.114
CA45-C035#106T	35	10	C	85	23	125	3.5	6	1.6	0.237	0.142	0.095
CA45-D035#106T	35	10	D	85	23	125	3.5	6	1	0.324	0.194	0.130
CA45-E035#106T	35	10	E	85	23	125	3.5	6	0.9	0.373	0.224	0.149
CA45-C035#156T	35	15	C	85	23	125	5.3	6	1.4	0.254	0.152	0.101
CA45-D035#156T	35	15	D	85	23	125	5.3	6	0.8	0.362	0.217	0.145
CA45-E035#156T	35	15	E	85	23	125	5.3	6	0.9	0.373	0.224	0.149
CA45-C035#226T	35	22	C	85	23	125	7.7	6	1.4	0.254	0.152	0.101
CA45-D035#226T	35	22	D	85	23	125	7.7	6	0.7	0.387	0.232	0.155
CA45-E035#226T	35	22	E	85	23	125	7.7	6	0.5	0.500	0.300	0.200
CA45-D035#336T	35	33	D	85	23	125	11.6	6	0.9	0.342	0.205	0.137
CA45-E035#336T	35	33	E	85	23	125	11.6	6	0.9	0.373	0.224	0.149
CA45-D035#476T	35	47	D	85	23	125	16.5	8	1.2	0.296	0.177	0.118

- # To complete part number , insert K for ±10% or M for ±20% .Designates capacitance tolerance.
- Please do not use multimeter through the measuring procedures.
- Capacitance and DF measured at :100Hz, U_r=2.2°-1.0V, U_w=1.0°-0.5V, Frequency=100Hz.Test only applied in series equivalent circuit.
- Voltage derating is applied at +125°C. (The DCL parameter should be read after 5 minutes when it connected to the circuit) .
- Special size and demand could consult with us.

RATING & PART NUMBER REFERENCE

Part Number	Rated Voltage (V)	Capacitance (μF)	Case Code	Rated Temp (°C)	Category Voltage	Category Temp (°C)	Max DCL(μA) @25°C	Max DF(%) @25°C 100Hz	Max ESR(mΩ) @25°C 100KHz	Max. Ripple @100KHz IRMS (A)		
										25°C	85°C	125°C
CA45-E035#476T	35	47	E	85	23	125	16.5	6	0.9	0.373	0.224	0.149
CA45-V035#476T	35	47	V	85	23	125	16.5	6	0.4	0.612	0.367	0.245
CA45-E035#686T	35	68	E	85	23	125	23.8	8	1	0.354	0.212	0.141
CA45-V035#686T	35	68	V	85	23	125	23.8	6	0.5	0.548	0.329	0.219
CA45-G035#107W	35	100	G	85	23	125	35.0	8	0.25	0.980	0.588	0.392
CA45-S035#107W	35	100	S	85	23	125	35.0	8	0.25	1.058	0.635	0.423
CA45-T035#107W	35	100	T	85	23	125	35.0	8	0.25	1.149	0.689	0.460
CA45-T035#157W	35	150	T	85	23	125	52.5	8	0.2	1.285	0.771	0.514
CA45-A050#474T	50	0.47	A	85	33	125	0.5	4	9.5	0.083	0.050	0.033
CA45-A050#684T	50	0.68	A	85	33	125	0.5	4	7.9	0.091	0.054	0.036
CA45-A050#105T	50	1	A	85	33	125	0.5	4	6.6	0.099	0.060	0.040
CA45-B050#105T	50	1	B	85	33	125	0.5	6	6	0.112	0.067	0.045
CA45-B050#155T	50	1.5	B	85	33	125	0.8	8	5.4	0.118	0.071	0.047
CA45-C050#155T	50	1.5	C	85	33	125	0.8	6	4.5	0.141	0.085	0.057
CA45-B050#225T	50	2.2	B	85	33	125	1.1	8	4.5	0.129	0.077	0.052
CA45-C050#225T	50	2.2	C	85	33	125	1.1	6	2.5	0.190	0.114	0.076
CA45-D050#225T	50	2.2	D	85	33	125	1.1	6	2.5	0.205	0.123	0.082
CA45-C050#335T	50	3.3	C	85	33	125	1.7	6	2	0.212	0.127	0.085
CA45-D050#335T	50	3.3	D	85	33	125	1.7	6	2	0.229	0.137	0.092
CA45-C050#475T	50	4.7	C	85	33	125	2.4	4	1.4	0.254	0.152	0.101
CA45-D050#475T	50	4.7	D	85	33	125	2.4	6	1.2	0.296	0.177	0.118
CA45-C050#685T	50	6.8	C	85	33	125	3.4	6	1	0.300	0.180	0.120
CA45-D050#685T	50	6.8	D	85	33	125	3.4	6	1	0.324	0.194	0.130
CA45-E050#685T	50	6.8	E	85	33	125	3.4	6	1.5	0.289	0.173	0.115
CA45-D050#106T	50	10	D	85	33	125	5.0	6	0.8	0.362	0.217	0.145
CA45-E050#106T	50	10	E	85	33	125	5.0	6	1	0.354	0.212	0.141
CA45-V050#106T	50	10	V	85	33	125	5.0	6	0.65	0.480	0.288	0.192
CA45-D050#156T	50	15	D	85	33	125	7.5	6	0.6	0.418	0.251	0.167
CA45-E050#156T	50	15	E	85	33	125	7.5	6	0.6	0.456	0.274	0.183
CA45-V050#156T	50	15	V	85	33	125	7.5	6	0.6	0.500	0.300	0.200
CA45-E050#226T	50	22	E	85	33	125	11.0	8	0.9	0.373	0.224	0.149
CA45-V050#226T	50	22	V	85	33	125	11.0	8	0.6	0.500	0.300	0.200
CA45-W050#336T	50	33	W	85	33	125	16.5	6	0.3	0.816	0.490	0.327
CA45-G050#336W	50	33	G	85	33	125	16.5	6	0.3	0.894	0.537	0.358
CA45-S050#476W	50	47	S	85	33	125	23.5	6	0.3	0.966	0.580	0.386
CA45-T050#476W	50	47	T	85	33	125	23.5	6	0.3	1.049	0.629	0.420
CA45-T050#686W	50	68	T	85	33	125	34.0	6	0.25	1.149	0.689	0.460
CA45-T050#107W	50	100	T	85	33	125	50.0	8	0.25	1.149	0.689	0.460
CA45-C063#105T	63	1	C	85	40	125	0.6	6	5	0.134	0.080	0.054
CA45-D063#155T	63	1.5	D	85	40	125	0.9	6	3.5	0.173	0.104	0.069
CA45-D063#225T	63	2.2	D	85	40	125	1.4	6	2	0.229	0.137	0.092
CA45-D063#335T	63	3.3	D	85	40	125	2.1	6	1.5	0.265	0.159	0.106
CA45-E063#475T	63	4.7	E	85	40	125	3.0	6	1	0.354	0.212	0.141
CA45-E063#685T	63	6.8	E	85	40	125	4.3	6	0.8	0.395	0.237	0.158
CA45-E063#106T	63	10	E	85	40	125	6.3	8	0.6	0.456	0.274	0.183
CA45-W063#106T	63	10	W	85	40	125	6.3	6	0.4	0.707	0.424	0.283
CA45-E063#156T	63	15	E	85	40	125	9.5	8	0.4	0.559	0.335	0.224
CA45-V063#156T	63	15	V	85	40	125	9.5	8	0.4	0.612	0.367	0.245
CA45-W063#156T	63	15	W	85	40	125	9.5	6	0.4	0.707	0.424	0.283
CA45-V063#226T	63	22	V	85	40	125	13.9	8	0.4	0.612	0.367	0.245
CA45-W063#226T	63	22	W	85	40	125	13.9	6	0.4	0.707	0.424	0.283
CA45-G063#226W	63	22	G	85	40	125	13.9	6	0.4	0.775	0.465	0.310
CA45-T063#336W	63	33	T	85	40	125	20.8	6	0.3	1.049	0.629	0.420
CA45-T063#476W	63	47	T	85	40	125	29.6	6	0.3	1.049	0.629	0.420
CA45-T063#686W	63	68	T	85	40	125	42.8	6	0.25	1.149	0.689	0.460

- # To complete part number , insert K for ±10% or M for ±20% .Designates capacitance tolerance.
- Please do not use multimeter through the measuring procedures.
- Capacitance and DF measured at :100Hz, U₊=2.2~-1.0V, U₋=1.0~-0.5V, Frequency=100Hz.Test only applied in series equivalent circuit.
- Voltage derating is applied at +125°C. (The DCL parameter should be read after 5 minutes when it connected to the circuit) .
- Special size and demand could consult with us.

A,B,C,D,E,V,W Case Product Packaging

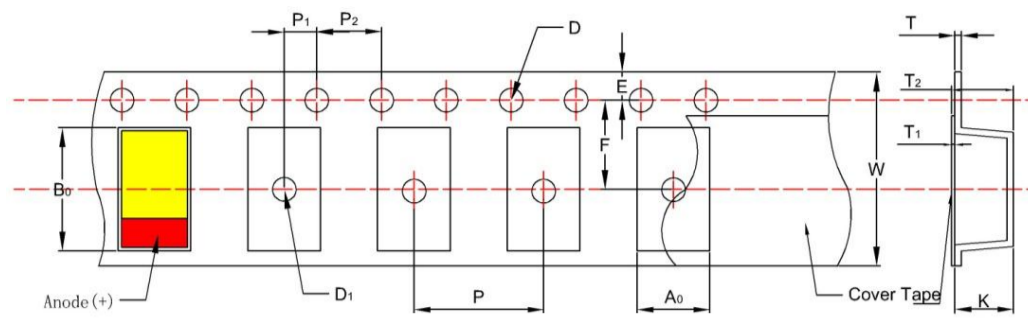

Embossed (Plastic) Carrier Tape Dimensions

Diagram of Taping Dimensions

Case	A ₀ ±0.10	B ₀ ±0.10	K±0.10	W±0.30	E±0.10	F±0.05	P±0.10	P ₁ ±0.05	P ₂ ±0.10	D+0.20	D ₁ +0.25
A	1.83	3.57	1.65	8	1.75	3.5	4	2	4	1.5	1
B	3.15	3.77	2.22	8	1.75	3.5	4	2	4	1.5	1
C	3.45	6.4	2.92	12	1.75	5.5	8	2	4	1.5	1.5
D	4.48	7.62	3.22	12	1.75	5.5	8	2	4	1.5	1.5
E	4.5	7.5	4.5	12	1.75	5.5	8	2	4	1.5	1.5
V	6.4	7.6	4.4	12	1.75	5.5	8	2	4	1.5	1.5
W	7.2	8.1	4.75	16	1.75	7.5	12	2	4	1.5	1.5

±0.2mm over 10 sprocket hole spaces

Reel Dimensions

Reel Size	Tape Wide	A	B	C	W	T
180mm (7")	8mm	178±2.00	50 min	13.0±0.50	8.4+1.5/-0	1.50±0.50
180mm (7")	12mm	178±2.00	50 min	13.0±0.50	12.4+1.5/-0	1.50±0.50
180mm (7")	16mm	178±2.00	50 min	13.0±0.50	16.4+1.5/-1	1.50±0.50

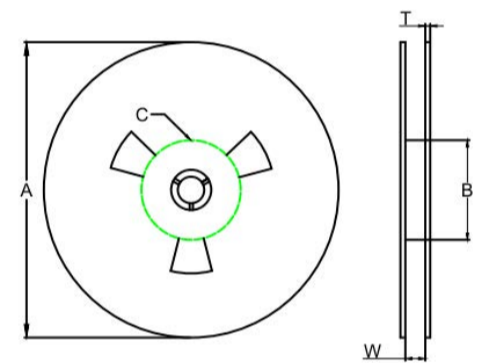

Reel Dimensions

Packaging Quantity

Case size	A	B	C	D	E	V	W
Quantity (pcs / plate)	2000	2000	500	500	400	400	400

G, S, T Case Product Packaging

The dimensions of the tray see the figure below . G size have 70 pcs per tray. Both Case size "S" and "T" have 40 pcs per tray .

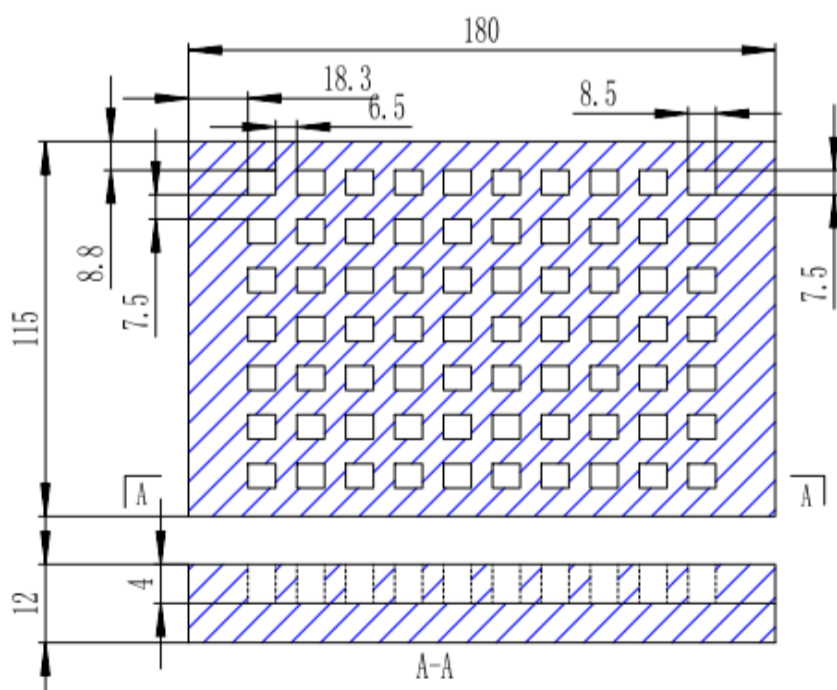

G Case Packaging

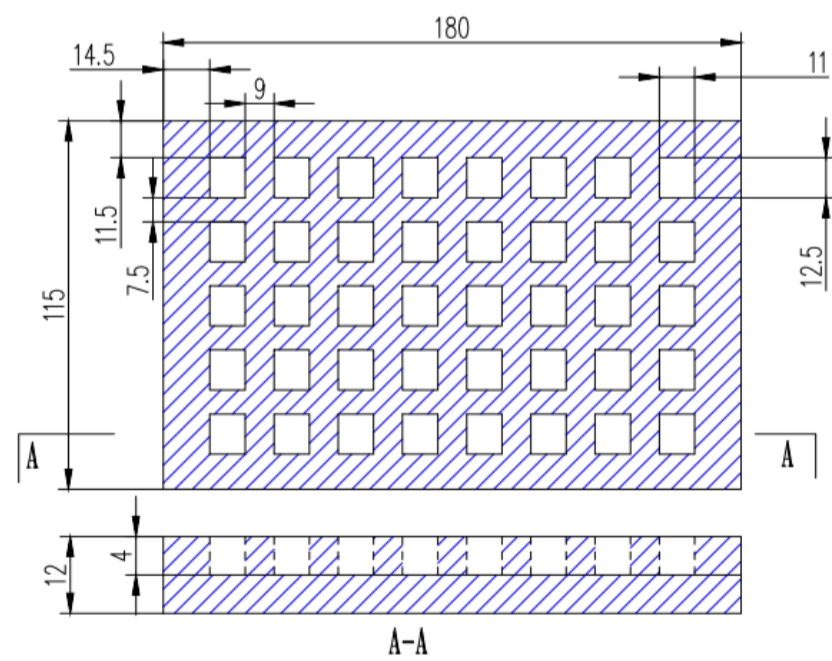

S,T Case Packaging

A.C. OPERATION, RIPPLE VOLTAGE AND RIPPLE CURRENT

In an a.c. application heat is generated within the capacitor by both the a.c. component of the signal (which will depend upon the signal form, amplitude and frequency), and by the d.c. leakage. For practical purposes the second factor is insignificant. The actual power dissipated in the capacitor is calculated using the formula:

$$P = I^2 R$$

and rearranged to $I = \text{SQRT} (P/R)$ (Eq. 1)

- where
- I = rms ripple current, amperes
 - R = equivalent series resistance, ohms
 - U = rms ripple voltage, volts
 - P = power dissipated, watts
 - Z = impedance, ohms, at frequency under consideration

Maximum a.c. ripple voltage (U_{max}). From the Ohms' law equation:

$$U_{max} = IR \text{(Eq. 2)}$$

Where P is the maximum permissible power dissipated as listed for the product under consideration (see tables).

However care must be taken to ensure that:

1. The d.c. working voltage of the capacitor must not be exceeded by the sum of the positive peak of the applied a.c. voltage and the d.c. bias voltage.
2. The sum of the applied d.c. bias voltage and the negative peak of the a.c. voltage must not allow a voltage reversal in excess of the "Reverse Voltage" .

Historical ripple calculations.

Previous ripple current and voltage values were calculated using an empirically derived power dissipation required to give a 10°C (30°C for polymer) rise of the capacitors body temperature from room temperature, usually in free air. These values are shown in Table below "Power Dissipation Ratings" . Equation 1 then allows the maximum ripple current to be established, and Equation 2, the maximum ripple voltage.

Power Dissipation Ratings (In Free Air)

Case Size	A	B	C	D	E	V	W	G	S	T
Max. Power Dissipation @+25°C (Watts)	0.065	0.075	0.090	0.105	0.125	0.150	0.200	0.240	0.280	0.330

Land Dimension /Courtyard

Case code	Metric Size Code	Density Level A: Maximum (Most) Land Protrusion (mm)					Density Level B : Median (Nominal) Land Protrusion (mm)					Density Level C: Minimum (Least) Land Protrusion (mm)				
		W	L	S	V1	V2	W	L	S	V1	V2	W	L	S	V1	V2
A	3216-18	1.35	2.20	0.62	6.02	2.8	1.23	1.8	0.82	4.92	2.3	1.13	1.42	0.98	4.06	2.04
B	3528-21	2.35	2.21	0.92	6.32	4.0	2.23	1.8	1.12	5.22	3.5	2.13	1.42	1.28	4.36	3.24
C	6032-25	2.35	2.77	2.37	8.92	4.5	2.23	2.37	2.57	7.82	4	2.13	1.99	2.73	6.96	3.74
D	7343-31	2.55	2.77	3.67	10.22	5.6	2.43	2.37	3.87	9.12	5.1	2.33	1.99	4.03	8.26	4.84
E	7343-43	2.55	2.77	3.67	10.22	5.6	2.43	2.37	3.87	9.12	5.1	2.33	1.99	4.03	8.26	4.84

Density Level A: For low-density product applications. Recommended for wave solder applications and provides a wider process window for reflow solder processes.

Density Level B: For products with a moderate level of component density. Provides a robust solder attachment condition for reflow solder processes.

Density Level C: For high component density product applications. Before adapting the minimum land pattern variations the user should perform qualification testing based on the conditions outlined in IPC standard 7351 (IPC-7351).

- 1 Height of these chips may create problems in wave soldering.
- 2 Land pattern geometry is too small for silkscreen outline.

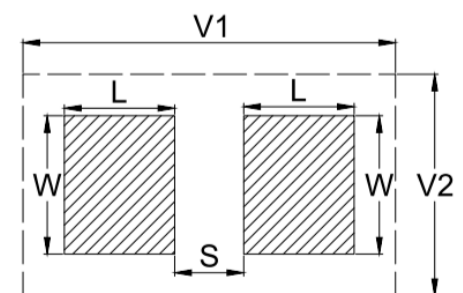

Surface Mount Footprints

Soldering Process

XIANGYEE tantalum capacitors are compatible with wave (single or dual), convection, IR, or vapor phase reflow techniques. Preheating of these components is recommended to avoid extreme thermal stress.

XIANGYEE's recommended profile conditions for convection and IR reflow reflect the profile conditions of the IPC/J-STD-020D standard for moisture sensitivity testing. The devices can safely withstand a maximum of three reflow passes at these conditions.

Hand soldering should be performed with care due to the difficulty in process control. If performed, care should be taken to avoid contact of the soldering iron to the molded case. The iron should be used to heat the solder pad, applying solder between the pad and the termination, until reflow occurs. Once reflow occurs, the iron should be removed immediately. "Wiping" the edges of a chip and heating the top surface is not recommended.

During typical reflow operations, a slight darkening of the gold-colored epoxy may be observed. This slight darkening is normal and not harmful to the product. Marking permanency is not affected by this change.

Profile Feature	SnPb Assembly	Pb-Free Assembly
Preheat/Soak		
Temperature Minimum (T_{smin})	100°C	150°C
Temperature Maximum (T_{smax})	150°C	200°C
Time (ts) from T_{smin} to T_{smax}	60 – 120 seconds	60 – 120 seconds
Ramp-up Rate (T_L to T_P)	3°C/seconds maximum	3°C/seconds maximum
Liquidous Temperature (T_L)	183°C	217°C
Time Above Liquidous (t_L)	60 – 150 seconds	60 – 150 seconds
Peak Temperature (T_P)	220°C* , 235°C**	250°C* , 260°C**
Time within 5°C of Maximum Peak Temperature (t_P)	20 seconds maximum	30 seconds maximum
Ramp-down Rate (T_P to T_L)	6°C/seconds maximum	6°C/seconds maximum
Time 25°C to Peak Temperature	6 minutes maximum	8 minutes maximum

Note: All temperatures refer to the center of the package, measured on the package body surface that is facing up during assembly reflow.

*Case Size D, E **Case Size A, B, C

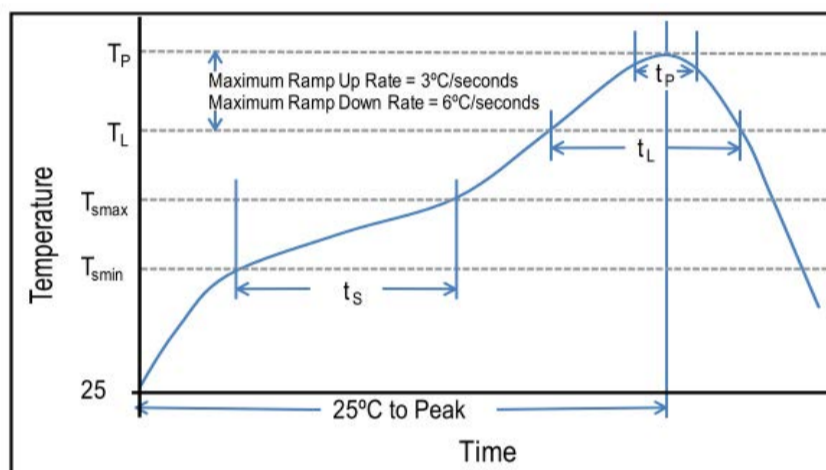

Recommended Reflow Profile

Storage

Tantalum dielectric chip capacitors are unaffected by the following storage condition for 2 years:

Temperature: -10°C – +40°C Humidity: 60% RH maximum

Atmospheric pressure: 860 mbar ~ 1060mbar

Tantalum capacitors exhibit a very low random failure rate after long periods of storage and apart from this there are no known modes of failure under normal storage conditions. All capacitors will withstand any environmental conditions within their ratings for the periods given in the detail specifications. Storage for longer periods under high humidity conditions may affect the leakage current of resin protected capacitors. Solderability of solder coated surfaces may be affected by storage of excess of 2 years.